



# User manual

## METER

### WW-30

- Firmware: v.5.18 or higher
- Input type: 0/4-20 mA, 0/1-5V, 0/2-10V
- Low-cost, no keyboard



Read the user's manual carefully before starting to use the unit or software.  
Producer reserves the right to implement changes without prior notice.

## **CONTENTS**

<b>1. BASIC REQUIREMENTS AND USER SAFETY</b> .....	<b>3</b>
<b>2. GENERAL CHARACTERISTICS</b> .....	<b>4</b>
<b>3. TECHNICAL DATA</b> .....	<b>4</b>
<b>4. DEVICE INSTALLATION</b> .....	<b>6</b>
4.1. UNPACKING.....	6
4.2. ASSEMBLY.....	6
4.3. CONNECTION METHOD.....	8
4.4. MAINTENANCE.....	12
<b>5. DESCRIPTION OF IR REMOTE CONTROLLER AND CONTROL SOFTWARE PUSH-BUTTONS</b> .....	<b>12</b>
<b>6. PRINCIPLE OF OPERATION</b> .....	<b>13</b>
6.1. MEASUREMENT MODE.....	13
6.2. DETECTION OF THE PEAK VALUES.....	14
<b>7. DEVICE PROGRAMMING</b> .....	<b>14</b>
7.1. PROGRAMMING MENU.....	15
7.2. PARAMETERS EDITION.....	15
7.2.1. Numeric parameters (digit change mode).....	15
7.2.2. Numeric parameters (slide change mode).....	16
7.2.3. Switch parameters ("LIST" type).....	16
7.3. MENU DESCRIPTION.....	17
7.3.1. "inPt" menu.....	17
7.3.2. "bri" parameter.....	22
7.3.3. "HOLd" menu.....	23
7.3.4. "Scod" parameter.....	23
7.3.5. "rS" menu.....	23
7.3.6. "Edit" parameter.....	24
7.3.7. "dEFS" parameter.....	24
7.3.8. "SErv" menu.....	24
7.4. MENU STRUCTURE.....	25
<b>8. OVER-CURRENT PROTECTION</b> .....	<b>26</b>
<b>9. DISPLAYED VALUES CALCULATION</b> .....	<b>26</b>
9.1. ADDITIONAL CALCULATIONS (USED CONVERSION CHARACTERISTIC).....	26
9.1.1. Linear characteristic.....	27
9.1.2. Square characteristic.....	27
9.1.3. Square root characteristic.....	28
9.1.4. User defined characteristic.....	28
9.1.5. Volume characteristics of a cylindrical tank.....	29
9.2. EXAMPLES OF CALCULATIONS.....	30
<b>10. THE MODBUS PROTOCOL HANDLING</b> .....	<b>34</b>
10.1. LIST OF REGISTERS.....	35
10.2. TRANSMISSION ERRORS DESCRIPTION.....	37
10.3. EXAMPLES OF QUERY/ANSWER FRAMES.....	37
<b>11. DEFAULT AND USER'S SETTINGS LIST</b> .....	<b>40</b>

**Explanation of symbols used in the manual:**



- This symbol denotes especially important guidelines concerning the installation and operation of the device. Not complying with the guidelines denoted by this symbol may cause an accident, damage or equipment destruction.

**IF THE DEVICE IS NOT USED ACCORDING TO THE MANUAL THE USER IS RESPONSIBLE FOR POSSIBLE DAMAGES.**



- This symbol denotes especially important characteristics of the unit. Read any information regarding this symbol carefully

**1. BASIC REQUIREMENTS AND USER SAFETY**



- **The manufacturer is not responsible for any damages caused by inappropriate installation, not maintaining the proper environmental conditions and using the unit contrary to its assignment.**
- Installation should be conducted by qualified personnel . During installation all available safety requirements should be considered. The fitter is responsible for executing the installation according to this manual, local safety and EMC regulations.
- GND input of device should be connected to PE wire;
- The unit must be properly set-up, according to the application. Incorrect configuration can cause defective operation, which can lead to unit damage or an accident.
- **If in the case of a unit malfunction there is a risk of a serious threat to the safety of people or property additional, independent systems and solutions to prevent such a threat must be used.**
- **The unit uses dangerous voltage that can cause a lethal accident. The unit must be switched off and disconnected from the power supply prior to starting installation of troubleshooting (in the case of malfunction).**
- Neighbouring and connected equipment must meet the appropriate standards and regulations concerning safety and be equipped with adequate overvoltage and interference filters.
- **Do not attempt to disassemble, repair or modify the unit yourself. The unit has no user serviceable parts. Defective units must be disconnected and submitted for repairs at an authorized service centre.**



- In order to minimize fire or electric shock hazard, the unit must be protected against atmospheric precipitation and excessive humidity.
- Do not use the unit in areas threatened with excessive shocks, vibrations, dust, humidity, corrosive gasses and oils.



- Do not use the unit in areas where there is risk of explosions.
- Do not use the unit in areas with significant temperature variations, exposure to condensation or ice.
- Do not use the unit in areas exposed to direct sunlight.
- Make sure that the ambient temperature (e.g. inside the control box) does not exceed the recommended values. In such cases forced cooling of the unit must be considered (e.g. by using a ventilator).



**The unit is designed for operation in an industrial environment and must not be used in a household environment or similar.**

## **2. GENERAL CHARACTERISTICS**

The **WW-30** is a simple digital panel indicator, equipped with two measurement inputs. One current input (0-20/4-20mA) and one voltage input (0-5/1-5/0-10/2-10V). Current input has additionally overcurrent protection circuit, which protects standard resistor.

The selection of active input is realised by software, and selected input can be changed at any time. Additionally the **WW-30** allows user to select a conversion characteristic of several kinds: linear, square, square root, and user defined (max.20 points length). Result is showed on 4-digit LED display. Displayed values range can be selected by user, from -999 to 9999, plus decimal point. Device **WW-30** is equipped with RS-485 / Modbus RTU communication interface .

The measurement range, active input and other parameters can be selected while ordering. The device can be configured via IR remote controller or, optionally by PC via RS-485 interface, or using simple RS-232 to IR converter. Moreover communication interface RS-485 enables data transmission in any monitoring system equipped witch Modbus RTU protocol.

Easy assembling, small dimensions, precision and reliability are the basic trumps of **WW-30** indicators.

IR remote controller is not a part of the **WW-30** and must be ordered separately.

## **3. TECHNICAL DATA**

Power supply voltage (depending on version)	230V AC $\pm 10\%$ ; 50 $\div$ 60 Hz (separated) or 110V AC $\pm 10\%$ , 50 $\div$ 60 Hz (separated) or 10... <b>24</b> ...30V DC (not separated)
External fuse (required)	T - type, max. 2 A
Power consumption	max. 1,5 VA @ 230V AC and @ 110V AC max. 1 W @ 24V DC
Current input	0 $\div$ 20 mA, 4 $\div$ 20 mA overload protected, maximum input current about 50 mA
Current measurement accuracy	$\pm 0,1\%$ @ 25°C; $\pm$ one digit (for 0 $\div$ 20 mA range)
Current input resistance	$\sim 50 \Omega$

Voltage input	0÷5 V, 1÷5 V, 0÷10 V, 2÷10 V
Voltage measurement accuracy	± 0,1% @ 25°C; ± one digit (for 0÷10 V range)
Voltage input resistance	~ 100 kΩ
Temperature stability	50 ppm / °C
Display range	-999 ÷ 9999, plus decimal point
Accepted prolonged input overload:	20%
Communication interface	RS 485, 8N1 and 8N2, Modbus RTU, not separated
Baud rate	1200 bit/s ÷ 115200 bit/s
Display	LED, 4 digit, 13mm height, red
Data memory	non-volatile memory, EEPROM type
Protection level	IP 65 (from front - option, IP 40 - standard) IP 20 (housing and connection clips)
Housing type	panel
Housing material	NORYL UL94V-0
Housing dimensions	for 24V DC version: 72 x 36 x 77 mm for 230V AC version: 72 x 36 x 94 mm
Mounting hole	67 x 32,5 mm
Assembly depth	for 24V DC version: min. 78 mm for 230V AC version: min. 95 mm
Panel thickness	max. 5 mm
Operating temperature (depending on version)	0°C to +50°C or -20°C to +50°C
Storage temperature (depending on version)	-10°C to +70°C or -20°C to +70°C
Humidity	5 to 90% no condensation
Altitude	up to 2000 meters above sea level
Screws tightening max. torque	0,5 Nm
Max. connection leads diameter	2,5 mm <sup>2</sup>
Safety requirements	according to: PN-EN 61010-1 installation category: II pollution degree: 2 voltage in relation to ground: 300V AC insulation resistance: >20MΩ insulation strength between power supply and input/output terminal: 1min. @ 2300V
EMC	according to: PN-EN 61326-1



**This is a class A unit. In housing or a similar area it can cause radio frequency interference. In such cases the user can be requested to use appropriate preventive measures.**

## **4. DEVICE INSTALLATION**

The unit has been designed and manufactured in a way assuring a high level of user safety and resistance to interference occurring in a typical industrial environment. In order to take full advantage of these characteristics installation of the unit must be conducted correctly and according to the local regulations.



- Read the basic safety requirements on page 3 prior to starting the installation.
- Ensure that the power supply network voltage corresponds to the nominal voltage stated on the unit's identification label.
- The load must correspond to the requirements listed in the technical data.
- All installation works must be conducted with a disconnected power supply.
- Protecting the power supply clamps against unauthorized persons must be taken into consideration.

### **4.1. UNPACKING**

After removing the unit from the protective packaging, check for transportation damage. Any transportation damage must be immediately reported to the carrier. Also, write down the unit serial number on the housing and report the damage to the manufacturer.

Attached with the unit please find:

- user's manual,
- warranty,
- assembly brackets - 2 pieces.

### **4.2. ASSEMBLY**



- The unit is designed for mounting inside housings (control panel, switchboard) insuring appropriate protection against surges and interference. Metal housings must be connected to ground in a way that complies with the governing regulations.
- Disconnect the power supply prior to starting assembly.
- Check the connections are wired correctly prior to switching the unit on.



In order to install the unit, a 67 x 32.5 mm mounting hole (Figure 4.1) must be prepared. The thickness of the material of which the panel is made must not exceed 5mm. Place the unit in the mounting hole inserting it from the front side of the panel, and then fix it using the brackets (Figure 4.2). The minimum distances between the centre points of multiple units - due to the thermal and mechanical conditions of operation - are 91 mm x 57mm (Figure 4.3).

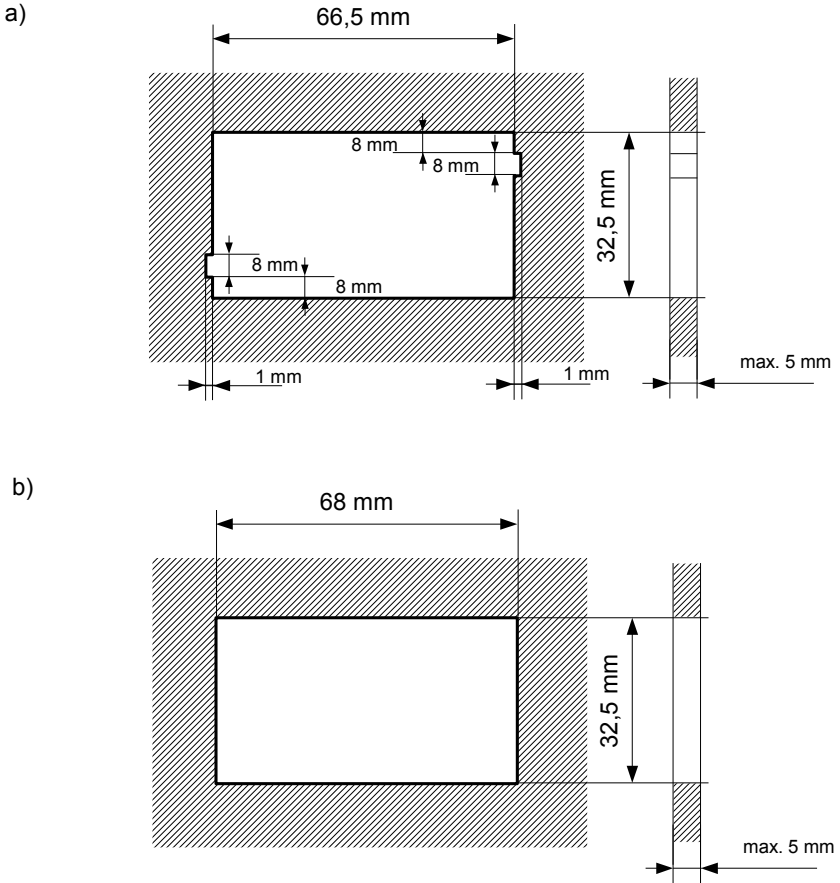

Figure 4.1. Mounting hole dimensions: a) recommended b) allowable

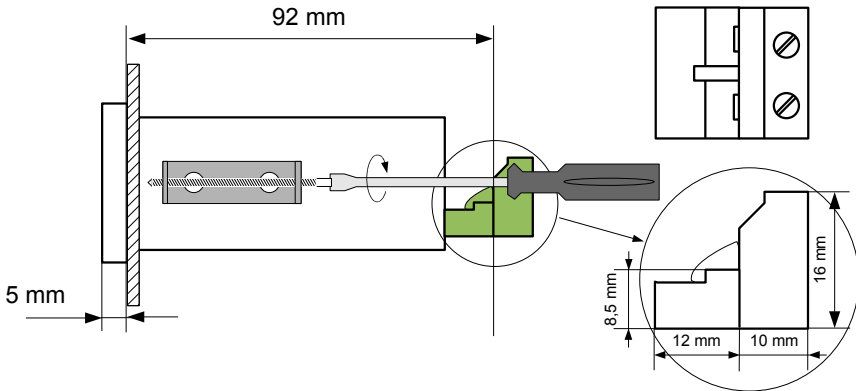

Figure 4.2. Installing of brackets, and dimensions of connectors.

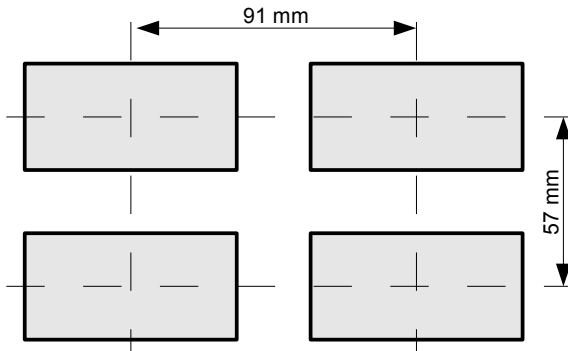

Figure 4.3. Minimum distances when assembly of a number of units

### 4.3. CONNECTION METHOD

#### Caution



- Installation should be conducted by qualified personnel . During installation all available safety requirements should be considered. The fitter is responsible for executing the installation according to this manual, local safety and EMC regulations.
- The unit is not equipped with an internal fuse or power supply circuit breaker. Because of this an external time-delay cut-out fuse with minimal possible nominal current value must be used (recommended bipolar, max. 2A) and a power supply circuit-breaker located near the unit. In the case of using a monopolar fuse it must be mounted on the phase cable (L).
- The power supply network cable diameter must be selected in such a way that in the case of a short circuit of the cable from the side of the unit the cable shall be protected against destruction with an electrical installation fuse.





- Wiring must meet appropriate standards and local regulations and laws.
- In order to secure against accidental short circuit the connection cables must be terminated with appropriate insulated cable tips.
- Tighten the clamping screws. The recommended tightening torque is 0.5 Nm. Loose screws can cause fire or defective operation. Over tightening can lead to damaging the connections inside the units and breaking the thread.
- In the case of the unit being fitted with separable clamps they should be inserted into appropriate connectors in the unit, even if they are not used for any connections.
- **Unused clamps (marked as n.c.) must not be used for connecting any connecting cables (e.g. as bridges), because this can cause damage to the equipment or electric shock.**
- If the unit is equipped with housing, covers and sealing packing, protecting against water intrusion, pay special attention to their correct tightening or clamping. In the case of any doubt consider using additional preventive measures (covers, roofing, seals, etc.). Carelessly executed assembly can increase the risk of electric shock.
- After the installation is completed do not touch the unit's connections when it is switched on, because it carries the risk of electrical shock.

**Due to possible significant interference in industrial installations appropriate measures assuring correct operation of the unit must be applied. To avoid the unit of improper indications keep recommendations listed below.**

- Avoid common (parallel) leading of signal cables and transmission cables together with power supply cables and cables controlling induction loads (e.g. contactors). Such cables should cross at a right angle.
- Contactor coils and induction loads should be equipped with anti-interference protection systems, e.g. RC-type.
- Use of screened signal cables is recommended. Signal cable screens should be connected to the earthing only at one of the ends of the screened cable.
- In the case of magnetically induced interference the use of twisted couples of signal cables (so-called "spirals") is recommended. The spiral (best if shielded) must be used with RS-485 serial transmission connections.
- In the case of measurement or control signals are longer than 30m or go outside of the building then additional safety circuits are required.
- In the case of interference from the power supply side the use of appropriate anti-interference filters is recommended. Bear in mind that the connection between the filter and the unit should be as short as possible and the metal housing of the filter must be connected to the earthing with largest possible surface. The cables connected to the filter output must not run in parallel with cables with interference (e.g. circuits controlling relays or contactors).

Connections of power supply voltage and measurement signals are executed using the screw connections on the back of the unit's housing.

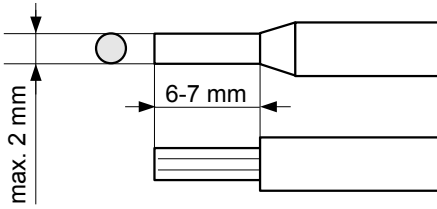

Figure 4.4. Method of cable insulation replacing and cable terminals

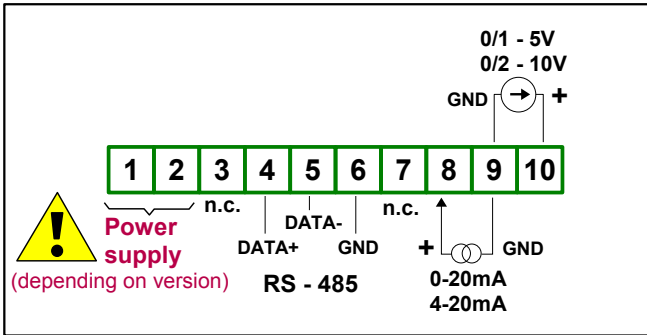

Figure 4.5. Terminals description



**All connections must be made while power supply is disconnected !**

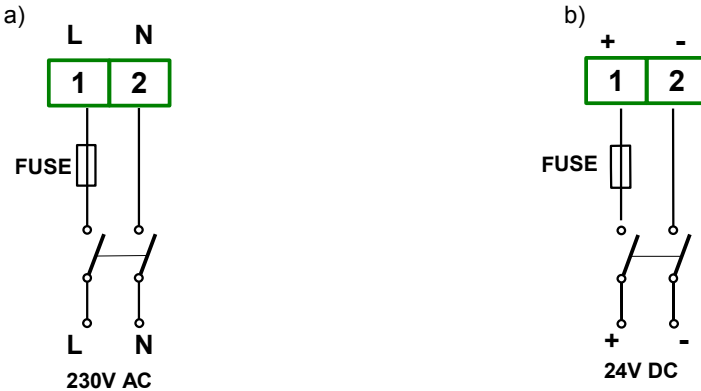

Figure 4.6. Connection of power supply  
a) for 230V AC version; b) for 24V DC version

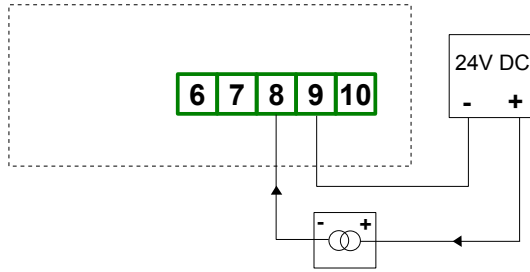

Figure 4.7. Connection of 2-wire current converters

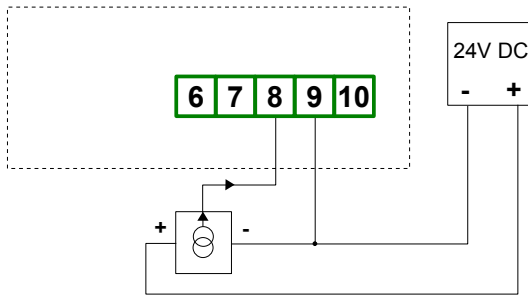

Figure 4.8. Connection of 3-wire current converters

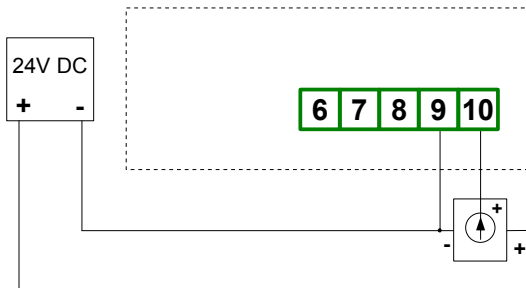

Figure 4.9. Connection of voltage converters

## 4.4. MAINTENANCE

The unit does not have any internal replaceable or adjustable components available to the user. Pay attention to the ambient temperature in the room where the unit is operating. Excessively high temperatures cause faster ageing of the internal components and shorten the fault-free time of unit operation.

In cases where the unit gets dirty do not clean with solvents. For cleaning use warm water with small amount of detergent or in the case of more significant contamination ethyl or isopropyl alcohol.



Using any other agents can cause permanent damage to the housing.



Product marked with this symbol should not be placed in municipal waste. Please check local regulations for disposal and electronic products.

## 5. DESCRIPTION OF IR REMOTE CONTROLLER AND CONTROL

### SOFTWARE PUSH-BUTTONS

infra-red  
transmitter



programming pushbuttons

#### Symbols and functions of push-buttons:



Symbol used in the manual: **[ESC/MENU]**

##### Functions:

- Enter to main menu ( press and hold by at least 2 sec.)
- Exit the current level and Enter to previous menu (or measure mode)
- Cancel the changes made in parameter being edited



Symbol used in the manual: **[ENTER]**

##### Functions:

- Start to edit the parameter
- Enter to the sub-menu,
- Confirmation of changes made in parameter being edited



Symbol used in the manual: [^] [v]

Functions:

- Change of the present menu,
- Modification of the parameter value,
- Change of the display mode.

## **6. PRINCIPLE OF OPERATION**

After turning the power supply on, device ID and software version are showed on the display, next the controller goes to the measurement mode.

### **6.1. MEASUREMENT MODE**

In the measure mode, the measurement results, converted over selected characteristic, are displayed on the LED display. The measurement range equal to the nominal range is called: **nominal measurement range**, and the measurement range equal to the extended nominal range is called: **permissible measurement range** (Figure 6.1, 6.2).

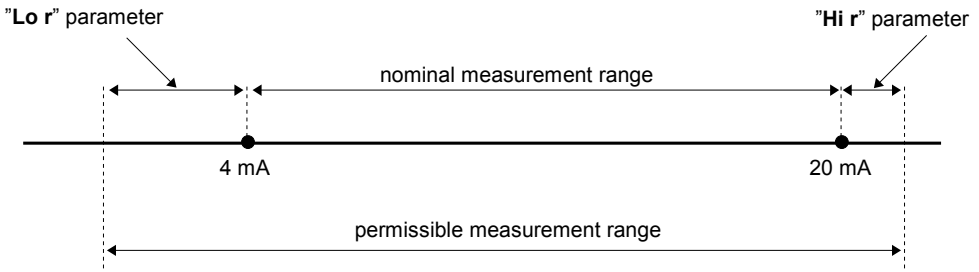

Figure 6.1. Definitions of measurement ranges in mode 4 ÷ 20mA

If the result of measurement exceeds the **permissible measurement range**, warning **”-Hi-”** or **”-Lo-”** is displayed rather than input signal, depends on exceeded value (see description of **”Lo r”** i **”Hi r”** parameters, paragraph **”inPt”** menu).

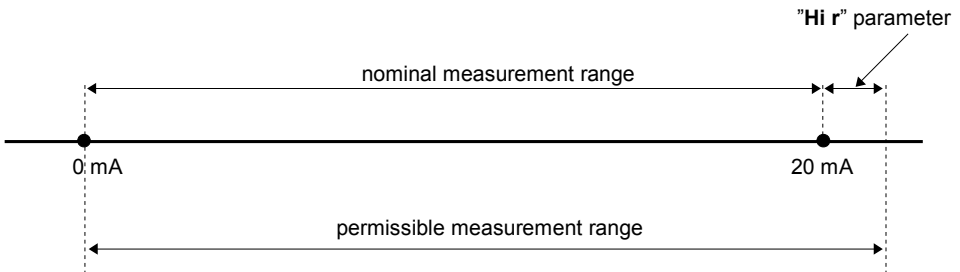

Figure 6.2. Definitions of measurement ranges in mode 0 ÷ 20mA



If the measurement value do not exceeds **permissible measurement range** but displayed value exceeds range -999 ÷ 9999, the warning **”-Ov-”** is displayed rather than the calculated result.

Input type, range of displaying values, characteristic of conversion, decimal point position and measure filtering ratio, are user configurable parameters. All accessible parameters can be changed by entering the menu (see: **DEVICE PROGRAMMING**). Use the local keyboard or the remote controller to do it. (Note: all parameters can be remote changed via RS-485 interface).



Configuration of the device (via menu or RS 485 interface) **do not stops measures**.

## 6.2. DETECTION OF THE PEAK VALUES

The **WW-30** controller is equipped with peaks detection function. It can detect a peaks of the input signal and display their values. Presets connected with this function are placed in **"HOLD"** menu (see description of **"HOLD" menu**). The detection of the peak can be done if the measured signal raises and drops of value at least equal to parameter **"PEA"**. Detected peaks are displayed during the time defined by parameter **"timE"**. If a new peak will be detected while one is displayed, this new peak will be displayed and display time counter will be cleared (Figure 6.3). If no peaks are detected while time **"timE"** elapses, device starts to show the current value of input signal again. If „HdiS”=**"HOLD"** then setting parameter **"timE"**=**0.0** causes holding peak value until **[ESC]** button is pressed. If „HdiS”=**"rEAL"** then value **"timE"**=**0.0** means no holding. Displaying peak value is signalized by flashing most right decimal point.

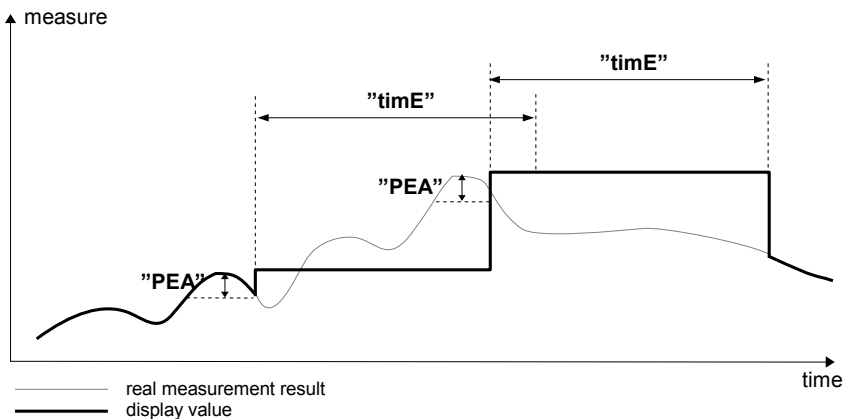

Figure 6.3. Process of peaks detection

## 7. DEVICE PROGRAMMING

The device menu allow user to set all parameters connected to operation of measurement input, control modes, critical situations behaviour, communication via RS-485 and access settings. The meaning of the particular parameters is described in paragraph **MENU DESCRIPTION**.

## **7.1. PROGRAMMING MENU**

To enter main menu (being in the measurement mode) operator must to press and hold at least 2 sec. **[ESC/MENU]** button.

If the user password is defined (see parameter “**Scod**“), operator have to enter correct one before proceeding to menu options . Entering of the passwords is similar to the edition of numeric parameters (see: **PARAMETERS EDITION** ), however presently editing digit is showed only on the display, other digits are replaced by “-” sign.

After entering of last digit of the password first menu position will be displayed (if the password is correct) or warning “**Err**” in other case.

### **Functions of the buttons while sub-menu and parameters choice:**



Selection of sub-menu or parameter for editing. Name of selected item (sub-menu or parameter) is displayed.



Operation of **[ENTER]** button depend on present menu position:

- if the name of some sub-menu is displayed - enter this sub-menu; name of the first parameter (or next level sub-menu) is displayed,
- if the name of some parameter is displayed - enter the edition of this parameter; present value of the parameter is displayed,



**[ESC/MENU]** button allow user to exit present menu level and goes to upper level menu (or measurement mode).



After about 1 min. since last use of the buttons, device exits the menu mode and returns to the measurement mode (only if no parameters are in editing mode).

## **7.2. PARAMETERS EDITION**

To start edition of any parameter user should select name of desired one using **[^]** **[v]** buttons and then press **[ENTER]**.

### **7.2.1. Numeric parameters (digit change mode)**

Numerical parameters are displayed as decimal numbers. The mode of its new value entering depends on chosen edit method ( see parameter „**Edit**“).

In mode “by digit” („**Edit**“=“**dig**“) pressing one of the keys **[^]** or **[v]** causes change of current position (flashing digit) or the sign (+/-). Short pressing of the **[ENTER]** button causes change of the position (digit).

Press **[ENTER]** at least 2 seconds to accept the changes, after that question “**Set?**” is displayed, and user must to confirm (or cancel) the changes. To conform changes (and store it in EEPROM) press **[ENTER]** button shortly after “**Set?**” is displayed. To cancel the changes press **[ESC]** button shortly after “**Set?**” is displayed. After that device returns to the menu.

### 7.2.2. Numeric parameters (slide change mode)

In “slide change” mode („Edit”=“Slid”), buttons [^] and [v] has different functions.

To increase edited value press (or press and hold) [^] button only, the increasing became quickest as long as button [^] is pressed. To slow down the increasing, button [v] can be used. If [v] is pressed shortly (and button [^] is still pressed), increasing slow down for a moment only, if [v] is pressed and held while button [^] is still pressed the increasing slow down and will be kept on lower speed.

To decrease edited value press (or press and hold ) [v] button only. The decreasing became quickest as long as button [v] is pressed. To slow down the decreasing, button [^] can be used. If [^] is pressed shortly (and button [v] is still pressed), decreasing slow down for a moment only, if [^] is pressed and held while button [v] is still pressed the decreasing slow down and will be kept on lower speed.

Press [ENTER] at least 2 seconds to accept the changes, after that question ”Set?” is displayed, and user must to confirm (or cancel) the changes. To conform changes (and store it in EEPROM) press [ENTER] button shortly after ”Set?” is displayed. To cancel the changes press [ESC] button shortly after ”Set?” is displayed. After that device returns to the menu.

### 7.2.3. Switch parameters (“LIST” type)

Switch parameters can be described as a sets of values (a lists) out of which only one of the options available on the list can be selected for the given parameter. Options of switching parameter are selected using [^], [v] keys.

Short pressing of [ENTER] causes in displaying of the acknowledge question (”Set?”). If key [ENTER] is pressed again, the changes are accepted, stored in EEPROM end the edition process finished. Pressing the key [ESC] after ”Set?” causes in cancelling of made changes and returning to menu.

#### Functions of buttons when editing numeric and switching parameters:



While editing numeric parameter:

- change of current (flashing) digit
- slide change of value (acceleration, deceleration, direction change)

While editing switch parameter - selection of switch parameter.



If numerical parameter is being edited, a short press of [ENTER] button change edited position. A long press of [ENTER] button (at least 2 sec.) causes of display a ”Set?” ask, which allow user to make sure if change of the parameter value is correct. If switch parameter is being edited, a short press of [ENTER] button causes of display a ”Set?” ask. When [ENTER] button is pressed again (while ”Set?” is displayed) the new value of the parameter is stored in EEPROM memory.



Pressing this button operator can cancel the changes done up to now (if they were not approved by [ENTER] button after the ”Set?” ask) and come back to menu



## 7.3. MENU DESCRIPTION

“- . - . -” - password checking. If some password different from „0000” is set, then every enter to main menu follows the entering of password. If entered password is correct then first menu position will be displayed else warning ”Err”, and unit returns to measurement mode.



Due to problem with direct displaying of “m” letter, it is exchanged with special sign “ $\bar{n}$ ”. Independently in user manual letter „m” is used to make it more readable (example: “modE”).

### 7.3.1. “inPt” menu

This menu presets the measurement input:

“tYPE” - type of the input / sensor. This parameter can be set to values:

“0-20”, “4-20” - current inputs.

“0-10”, “2-10”, “0-5”, “1-5” - voltage inputs.

Displayed values are defined by parameters “Lo C”, “Hi C” (or by user defined characteristic points) and parameter “Pnt”.

“CHAR” - this option presets type of the conversion characteristic, and can be set to:

“Lin” - linear

“Sqr” - square

“Sqrt” - square root

} When one of those characteristics is chosen display range is defined by “Lo C” and “Hi C”.

“USER” - user defined characteristic. Maximal length 20 points. Every point is defined by user. Adding, Editing and Deleting of points is done by options „AddP”, „EdtP”, „dELP” („InPt” menu) respectively.

“tn v” - volume characteristics of a cylindrical tank in the vertical position, determined by parameters: „t h1”, „t h2”, „t h3”, „t d”, „t Sn”, „t Sh” in „InPt” menu (see below for details of the parameters),

“n h” - volume characteristics of a cylindrical tank in the horizontal position, determined by parameters: „t h1”, „t h2”, „t h3”, „t d”, „t Sn”, „t Sh” in „InPt” menu (see below for details of the parameters).



If user defined characteristic is selected, and if number of defined points is lower than 2 then warning ”Errc” is displayed in measurement mode.

The process of displayed result calculation is described in details in **DISPLAY VALUES CALCULATION** paragraph.

“FiLt” - this parameter sets filtration rate. It can be set to values from 0 (no filtration ) to 5 (strongest filtration – time window about 2 sec).

“Pnt” - decimal point position. It can be set to one of:

“ 0”, “ 0.0”, “ 0.00”, “0.000”

Decimal point position is changed by [^], [v] buttons.

**“Lo C”** These parameters describe the values displayed for minimum and maximum input current. For example, if input type is set to 4-20 mA **“Lo C”** parameter defines the value displayed when input current is equal 4 mA, and **“Hi C”** parameter defines the value displayed for 20 mA of input current. Available range for these parameters: -999 ÷ 9999. Negative values can be set by entering '-' sign on the first position (by use of **[^]**, **[v]** buttons).



If volume characteristics of a cylindrical tank is selected (parameter **“CHAr”** = **”tn v”** or **“CHAr”** = **”tn h”**) the parameters **„Lo C”** and **„Hi C”** are not available.

**„t h1”**, **„t h2”**, **„t h3”**, **„t d”** - the parameters defining shape of cylindrical tank (Figure 7.1 and Figure 7.2).

a) for the cylindrical tank in the vertical position:

**„t h1”** - the height of the bottom part of a tank (in the elliptic paraboloid shape), this parameter has the fixed precision - 2-decimal point,

**„t h2”** - the height of the middle part of a tank in the cylindrical shape, this parameter has the fixed precision - 2-decimal point,

**„t h3”** - the height of the top part of a tank (in the elliptic paraboloid shape), this parameter has the fixed precision - 2-decimal point,

**„t d”** - the diameter of the middle part of a tank, this parameter has the fixed precision - 2-decimal point,

b) for the cylindrical tank in the horizontal position:

**„t h1”** - the length of the left bottom of a tank (in the elliptic paraboloid shape), this parameter has the fixed precision - 2-decimal point,

**„t h2”** - the length of the middle part of a tank in the cylindrical shape, this parameter has the fixed precision - 2-decimal point,

**„t h3”** - the length of the right bottom of a tank (in the elliptic paraboloid shape), this parameter has the fixed precision - 2-decimal point,

**„t d”** - the diameter of the middle part of a tank, this parameter has the fixed precision - 2-decimal point,

**„t Sn”**, **„t Sh”** - parameters defining the length and position of the sensor used to measure level of liquids, gases or solids in the tank (Figure 7.1, 7.2).

**„t Sn”** - distance between end of the sensor and bottom of the tank, this parameter has the fixed precision 2-decimal point but the unit is 100 times smaller than **“t Sh”** (see Info below),

**„t Sh”** - the measuring range, this parameter has the fixed precision - 2-decimal point.



- The unit value of “**t Sn**” parameter is 100-fold less than the unit value of other parameters defining cylindrical tank, i.e. if we set value 10.00 in “**t Sh**” parameter and set value 08.00 in “**t Sn**” parameter this mean that value of “**t Sn**” parameter is real has 00.08 value in preserved unit of the “**t Sh**” parameter.
- If we set parameters of tank in [**m**] unit (“**t Sn**” parameter takes [**cm**] unit respectively, see above), than displays the result the volume of the tank in [**m<sup>3</sup>**] unit, if we set parameters of tank in [**cm**] unit (“**t Sn**” parameter takes [**mm**] unit respectively, see above), than displays the result the volume of the tank in [**cm<sup>3</sup>**] unit.
- “**t Sh**” parameter may be greater than height (for vertical position) or diameter (for horizontal position) of the tank, which means that the total volume of the tank can be achieved by eg. such middle-current range,
- If the measurement value do not exceeds permissible measurement range but displayed value exceeds range of 9999 than you can move to the right position of the decimal point if it is still possible (see parameter Menu->“**inPt**”->“**Pnt**”).
- If in the volume characteristics of a cylindrical tank is exceeded the value of the volume of the tank sets by parameters available in menu “**inPt**” instead of the calculated result will be display warning “-Hi-”.

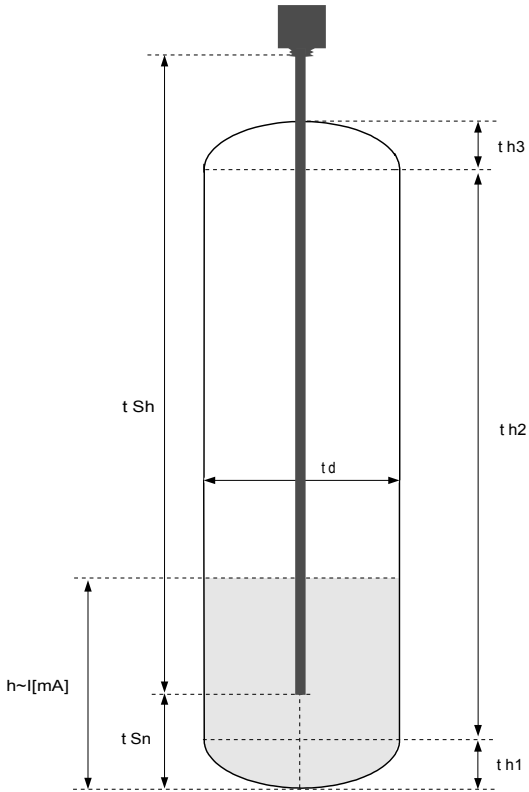

Figure 7.1 Parameters of cylindrical tank in vertical position.

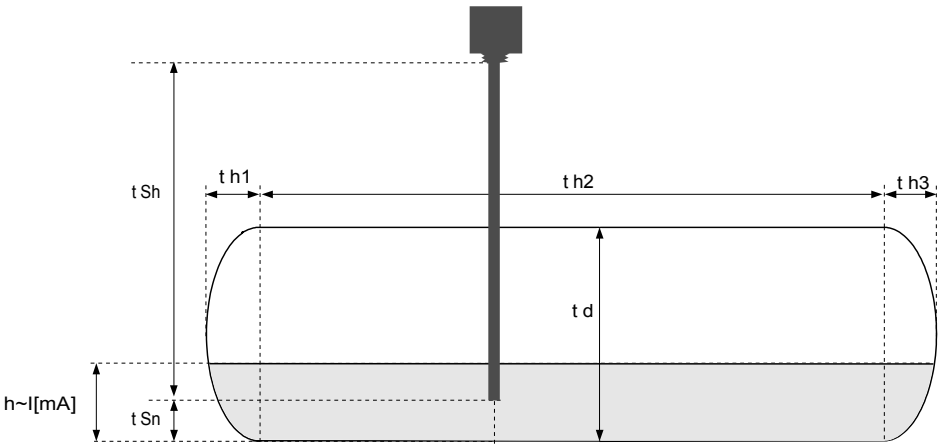

Figure 7.2 Parameters of cylindrical tank in horizontal position.



If user defined characteristic is selected (parameter “**CHAR**” = “**USER**”) the parameters „**Lo C**” and „**Hi C**” are not available for modification, due to their values are calculated from defined characteristic.

**“AddP”**

- this menu allow user to add single point to the user defined characteristic. After selection of this option device waits for „**X**” and „**Y**” coordinates of new point. Modification of the coordinates is done accordingly to numerical parameters edition. Coordinate „**X**” defines the percentage ratio of input current to selected current range. The „**X**” range:  $-99,9 \div 199,9$ . Coordinate „**Y**” defines displayed value for particular „**X**” value. The „**Y**” value can be changed in range:  $-999 \div 9999$ , decimal point position depend on „**Pnt**” parameter (menu “**inPt**”).



- User can not enter two points with the same value of „**X**” coordinate. If user trays to do it, “**Err**” warning is displayed. To modify any defined point use “**EdtP**” option.
- To distinguish „**X**” and „**Y**” coordinates, if „**X**” coordinate is displayed an additional decimal point on utmost right position is displayed.
- If user defined characteristic is selected, and if number of defined points is lower than 2 then warning “**Errc**” is displayed in measurement mode.

**“dELP”**

- this option allows user to delete any of the points of the user defined characteristic. After selection current number of points of the user defined characteristic is displayed for about approx. 1.5 sec. After that device waits for selection of point being deleted (by [**^**], [**v**] buttons). The short pressing of [**ENTER**] button causes by switching between **X** and **Y** value of the displayed point. The long press (press and hold at least 2 sec) of [**ENTER**] button causes by displaying „**dEL?**” ask. If [**ENTER**] button is pressed again, current point is deleted and new updated number of points of the user defined characteristic is displayed.

**“EdtP”**

- this option allows user to modify of particular point of the user defined characteristic. After selection current number of points of the user defined characteristic is displayed for about approx. 1.5 sec. After that device waits for selection of point being edited (by [**^**], [**v**] buttons). The short pressing of [**ENTER**] button causes by switching between **X** and **Y** value of the displayed point. The long press (press and hold at least 2 sec) of [**ENTER**] button causes by entering to edit the selected coordinate of the point. Modification of the coordinates is done accordingly to numerical parameters edition.



“**AddP**”, “**dELP**” and “**EdtP**” options are available only if the user defined characteristic is used (it means when parameter “**CHAR**” = “**USER**”).

**“Lo r”, “Hi r”**

- these parameters define the expansion of nominal range in percent. They determine the permissible range of input signal (Figure 7.3).

The permissible range allow user to exceed the **nominal range** of input signal. If input value is contained in the permissible range a proper result is displayed. If input signal exceeds this range (defined by “**Lo r**” and “**Hi r**”), “**-Lo-**” or “**-Hi-**” warning is displayed depend on input signal value.

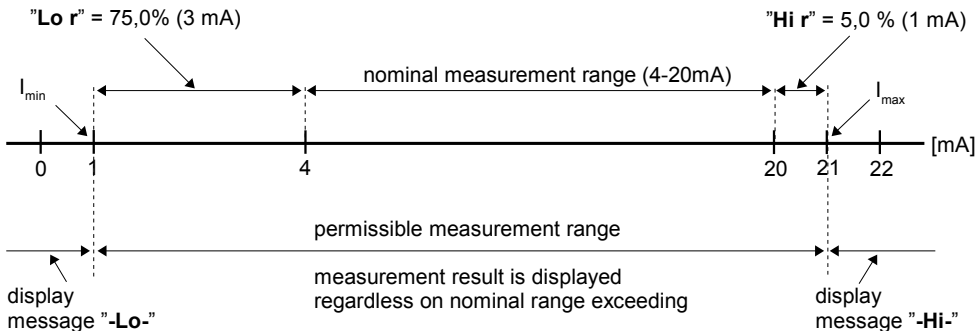

Figure 7.3 Example of definition of permissible range of input signal - "Lo r" and "Hi r" parameters ("4-20" mode)

The "Lo r" parameter is important if input is set to "4-20", "1-5" or "2-10" mode only, and determines lower border of the permissible range. If input is set to "0-20", "0-5" or "0-10" mode then lower border of the permissible range is always 0.

For example if input is set to "4-20" mode, then lower border is calculated due to expression:  $I_{\min} = 4 \text{ mA} - 4 \text{ mA} \times \text{"Lo r"} \%$ .

The "Lo r" value can be set from 0 to 99.9%.

Parameter "Hi r" determines the upper border of the permissible range accordingly to the expression (for all modes).

For example if input is set to "4-20" mode, then upper border is calculated due to expression:  $I_{\max} = 20 \text{ mA} + 20 \text{ mA} \times \text{"Hi r"} \%$ .

The value of "Hi r" can be set from 0 to 19.9%

In example no 1 of the **DISPLAY VALUES CALCULATION** paragraph the procedure of the permissible input range determining is presented in details.



If the measurement value do not exceeds **permissible measurement range** but displayed value exceeds range -999 ÷ 9999, the warning "-Ov-" is displayed rather than the calculated result.

### 7.3.2. "bri" parameter

This parameter allows user to set bright of the LED display, bright can be set to conventional values from 1 to 8.

### **7.3.3. "HOLd" menu**

This menu contains parameters connected with peak detection function. See also full description of the peak detection function in paragraph: **DETECTION OF THE PEAK VALUES**

**"modE"** - the type of detected changes of the input signal, can be set to values:

- "norm"** - peaks, peak and next drop of the input signal of value equal at least **"PEA"**,
- "inv"** - drops, drop and next peak of the input signal of value equal at least **"PEA"**,

**"PEA"** - minimal detected signal change classified as peak or drop (see Figure 6.3)

**"timE"** - maximum time of displaying of the peak (drop) value, can be set from 0.0 to 19.9 sec, with 0.1 sec. resolution. If „**HdiS**”=**"HOLD"** then setting parameter **"timE"**=**0.0** causes holding peak value until **[ESC]** button is pressed. If „**HdiS**”=**"rEAL"** then value **"timE"**=**0.0** means no holding.

**"HdiS"** - type of displayed values:

- "rEAL"** - current value is displayed,
- "HOLd"** - peak (drop) value is displayed,

### **7.3.4. "Scod" parameter**

This parameter defines user password (4-digits number). If this parameter is set at value **"0000"**, user password is turned off.

**If the user do not remember his password, the access to the menu is possible by the "one-use password". To get this password please contact with Marketing Division. "Single use password" can be used only one time, after that it is destroyed. Entering this password causes in clearing of user password, it means sets the user password to „0000".**



The "one-use password" can be used **ONE TIME ONLY**, it is impossible to use it again! The "one-use password" can be restored by Service Division only.

### **7.3.5. "rS" menu**

This menu is connected with RS-485 interface, and sets his properties:

- "Addr"** - this parameter defines the address of the device, accordingly to Modbus protocol. It can be set in range from 0 to 199. If the value 0 is set then device, responds to frames with address 255 (FFh).
- "bAud"** - this parameter determines RS-485 interface baud rate. It can be set to one of 8 possible values: **"1.2"**, **"2.4"**, **"4.8"**, **"9.6"**, **"19.2"**, **"38.4"**, **"57.6"**, **"115.2"**, which respond to the baud rates of 1200, 2400, 4800, 9600, 19200, 38400, 57600 and 115200 bit/s respectively.

**"mbAc"** - this parameter sets the access to the configuration registers of the device.

Possible values:

- "on"** - configuration registers can be set via RS-485 interface,
- "oFF"** - configuration registers can not be set via RS-485 interface.

**"rESP"** - this parameter defines minimal (additional) delay between the Modbus message and the answer of the device (received and sent via RS-485 interface). This additional delay allows the device to work with poor RS-converter which do not works properly on baud rates higher than 19200. This parameter can be set to one of values:

- "Std"** - answer as quick as possible, no additional delay
  - " 10c"**
  - " 20c"**
  - " 50c"**
  - "100c"**
  - "200c"**
- } - answer delayed of 10, 20, 50, 100 of 200 chars respectively, where one character time depends on selected baud rate



In the most cases parameter **"rESP"** should be set to **"Std"** (no additional delay). Unfortunately for some third party RS-converter **"rESP"** should be adjusted experimentally. Table 7.1 contains most frequently used values.

<b>"bAud" parameter</b>	"38.4"	"57.6"	"115.2"
<b>"rESP" parameter</b>	" 10c"	" 20c"	" 50c"

Tab.7.1. Settings of **"rESP"** parameter

### 7.3.6. "Edit" parameter

This parameter allows to change the edition mode of numerical parameters:

- "dig"** - the change to "by digit" mode,
- "Slid"** - slide change mode.

### 7.3.7. "dEFS" parameter

This setting allows to restore the factory settings of the device. To get the access to this option special password is required: „5465“, next the device displays acknowledge question „Set?“. Press **[ENTER]** to acknowledge the restoring of factory settings or **[ESC]** to cancel.

### 7.3.8. "SErv" menu

This menu contains the parameters for authorized service only. To enter this menu proper service password must be entered. Improper settings can causes of damage of the device.



## 7.4. MENU STRUCTURE

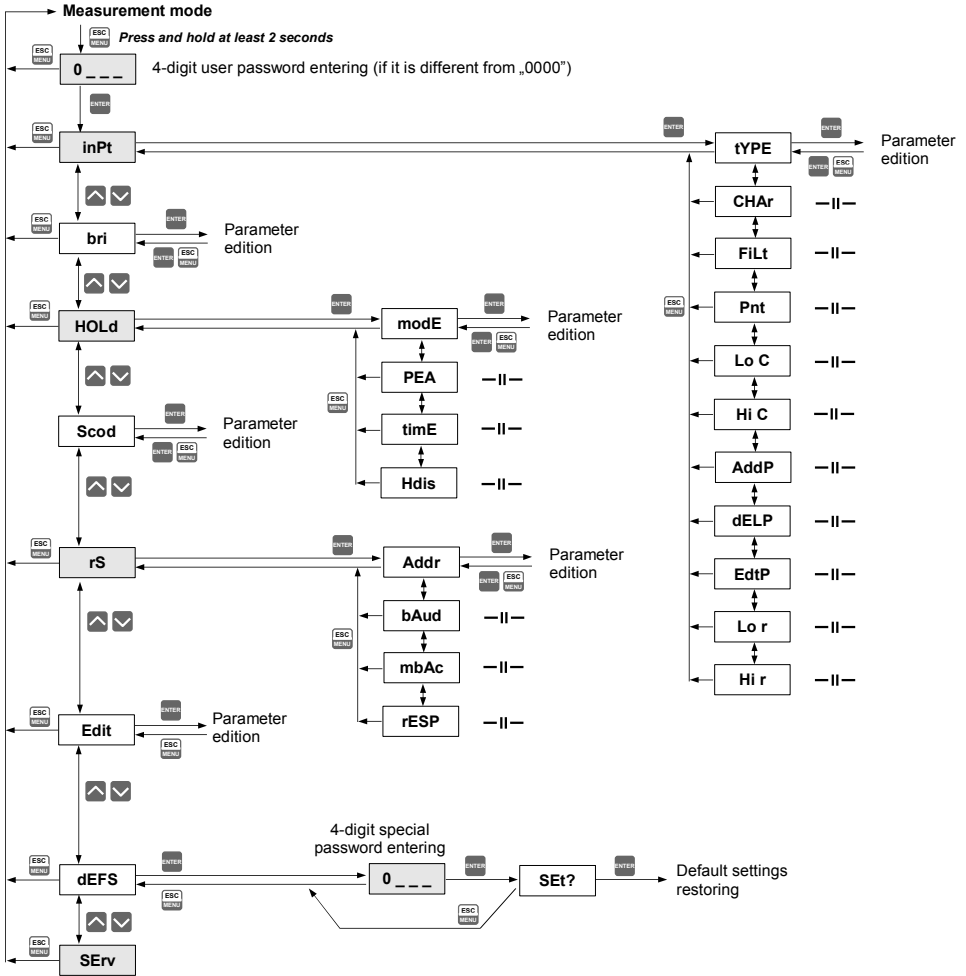

## **8. OVER-CURRENT PROTECTION**

The current input of the device is equipped with over-current protection circuit. This circuit protects the standard resistor against damage. Maximum input current is set to about 50 mA. When temperature of the standard resistor falls, the protection circuit will turn on automatically, and the device will measure the input current again. Due to thermal phenomenon in the standard resistor, precision of the measurement may be lower until to the standard resistor temperature will falls to the environment temperature.

## **9. DISPLAYED VALUES CALCULATION**

For simplicity of examples it's assumed that current input is selected, and all calculations are related to this input. When voltage input is selected calculations are similar (be sure of particular ranges and units).

The first step to compute the result of measure is the calculation of the normalized result (it means result of 0-1 range). To do it, the begin of the input range (0 mA for 0-20mA range, and 4mA for 4-20mA range) must be subtracted from measured value. Next, received result must be divided by the width of the input range ( it means 20mA for 0-20mA range, and 16mA for 4-20mA range). So normalized result can be expressed by expressions:

$$I_n = \frac{I_{inp} - 4}{16} \quad \text{for } 4 \div 20 \text{ mA range}$$

$$I_n = \frac{I_{inp}}{20} \quad \text{for } 0 \div 20 \text{ mA range}$$

where  $I_{inp}$ . Means input current (in mA), and  $I_n$  - normalized result.



If measured value exceeds the nominal input range (0-20mA or 4-20mA), and do not exceed the permissible input range, then received normalized  $I_n$  result exceeds 0-1 range, e.g. input range 4-20 mA, input current = 3 mA – the normalized result is equal -0,0625, and for input current = 22 mA, the normalized result is equal 1,125. In such cases presented expressions are still correct.

### **9.1. ADDITIONAL CALCULATIONS (USED CONVERSION CHARACTERISTIC)**

The manner of the additional computation of the displayed result depends on selected conversion characteristic. All presented charts are connected with the input range 4 - 20 mA.

### 9.1.1. Linear characteristic

The normalized result is converted by fixed coefficients determined by “Lo C” and “Hi C” parameters (when the normalized results is equal 0, then value “Lo C” is displayed, and when the normalized results is equal 1, then value “Hi C” is displayed). Expression presented below shows the manner of result calculation:

$$W = I_n \times ("Hi C" - "Lo C") + "Lo C",$$

where **W** means the displayed value.



The value of the “Lo C” parameter can be higher than the value of “Hi C” parameter. In such a case, for an increasing value of input current the displayed value decreases.

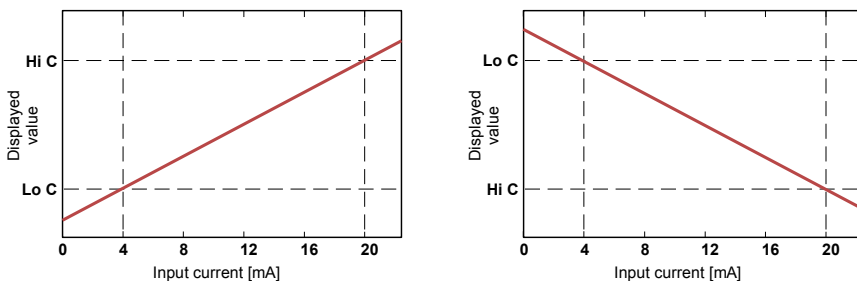

Figure. 9.1 Normal („Lo C” < ”Hi C”) and inverted („Lo C” > ”Hi C”) characteristic

### 9.1.2. Square characteristic

The normalized result is squared and further conversion is done as for linear characteristic. Conversion is made accordingly with the expression:

$$W = I_n^2 \times ("Hi C" - "Lo C") + "Lo C",$$

where **W** means the displayed value.

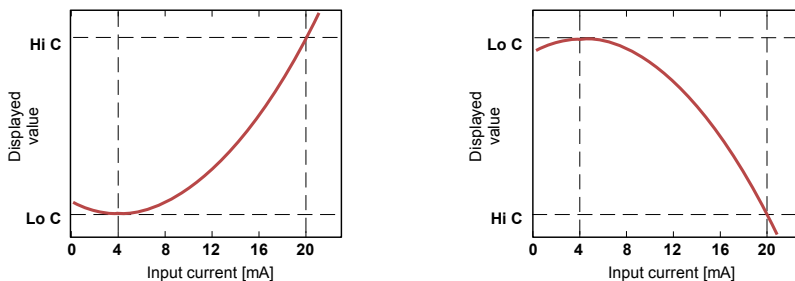

Figure. 9.2 Normal („Lo C” < ”Hi C”) and inverted („Lo C” > ”Hi C”) characteristic

### 9.1.3. Square root characteristic

The normalized result is rooted and further conversion is done as for linear characteristic. Conversion is made accordingly with the expression:

$$W = \sqrt{I_n} \times ("Hi C" - "Lo C") + "Lo C",$$

where W means the displayed value.



Shown above expression is not valid when normalized result is negative. It is possible for 4-20 mode only. In this case ( $I_n < 0$ ) the displayed result is equal "Lo C" (see graphs below).

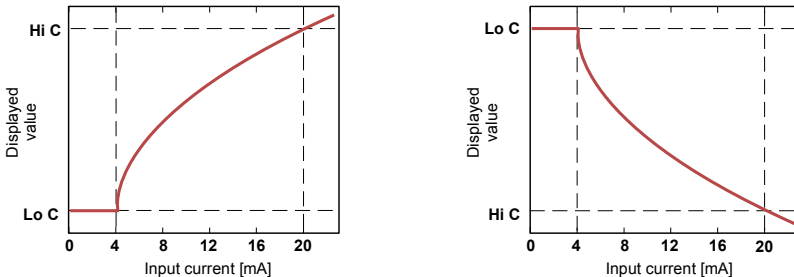

Figure. 9.3 Normal („Lo C” < ”Hi C”) and inverted („Lo C” > ”Hi C”) characteristic

### 9.1.4. User defined characteristic

User defined characteristic is defined as set of X-Y points. Number of the points is variable and may be set from 2 to 20 points which make linear segments (see graph and see **Menu "inPt"**). Due to the normalized result  $I_n$ , the device computes specific segment, e.g. for characteristic from figure below, and  $I_n = 0,65$  the segment between points X = "50.0." and X = "70.0." will be chosen.

Let's mark those points as PL (point low) i PH (point high) - in this example PL= "50.0," and PH = "70.0.", and the normalized result  $I_n$  for the point PL as  $I_p$  (in this example  $I_p = I_n(PL) = 0,5$ ). The displayed result is calculated accordingly to the expression:

$$W = (I_n - I_p) \times \frac{[Y(PH) - Y(PL)]}{[X(PH) - X(PL)]} \times 100 + Y(PL)$$

where Y(PH), X(PH), Y(PL), X(PL) mean values of X and Y coordinates of PH i PL points.



If the normalized result exceeds the user defined characteristic values, then specific utmost segment, defined by two next points, is used for calculations. If characteristic from figure below is used, and if  $I_n > 1$  then segment defined by points X(PL) = "90.0.", X(PH) = "100.0." will be used.

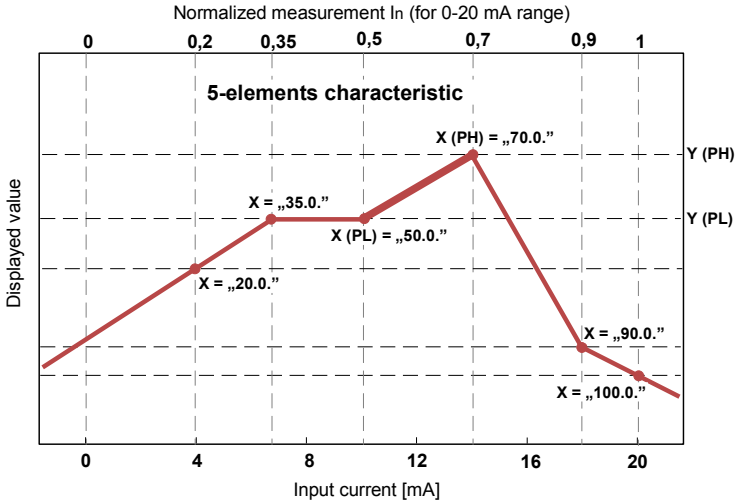

Figure. 9.4 Example of user defined characteristic

**9.1.5. Volume characteristics of a cylindrical tank**

Volume characteristics of a cylindrical tank is defined by parameters of tank (see menu "inPt"). Normalized input is proportional to level 'h' and linear scaling by parameters: "t Sn", "t Sh" (for normalized input value equal 0, displays value "t Sn" and for normalized input value equal 1, displays value "t Sh"+"t Sn" (Figure 9.5). The linear scaling can be expressed as follow:

$$h = I_n \cdot "t Sh" + "t Sn"$$

where 'h' is level of liquids, gases or solids in the tank, see Figure 7.1, 7.2.

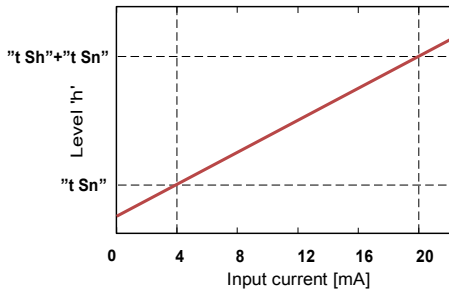

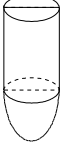
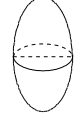

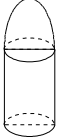





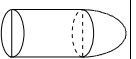



Figure 9.5 The characteristic of level of liquids, gases or solids in tank depending on input current in 4÷20mA range.

Volume of tank can be write by general formula:

$$V = \int P_p \cdot dh$$

Possible combination of tank shape for calculation the volume:

cylindrical tank in vertical position							
cylindrical tank in horizontal position							
parameters setting (for vertical and horizontal position of tank)	t h2=0 t h3=0	t h3=0	t h2=0	t h1=0 t h3=0	-	t h1=0	t h1=0 t h2=0

## 9.2. EXAMPLES OF CALCULATIONS

### Example 1: Selection of the permissible input range (“4-20” mode)

If in “4-20” mode the user sets “Lo r” = 20,0% and “Hi r” = 10,0%, then permissible input currents range will be equal: 3,2 mA ÷ 22 mA. Lower border of the range is the result of calculations: 4 mA - 4 mA × 20%, and the higher : 20 mA + 20 mA × 10%.

### Example 2: The normalized $I_n$ result calculation

Let the input mode = 4-20 mA. The normalized  $I_n$  result is calculated accordingly to the expression on page 26, so if  $I_{in} = 10$  mA then  $10$  mA - 4 mA = 6 mA, and this result should be divided by the width of input range (16 mA). Finally the normalized result:  $I_n = 6/16 = 0,375$ .

In case when input current exceeds nominal measurement range, calculations are similar. For example if input current is equal 2,5 mA then  $I_n = (2,5 - 4)/16 \cong -0,0938$ , and if input current is equal 20,5 mA then  $I_n = (20,5 - 4)/16 \cong 1,0313$ .

### Example 3: The linear characteristic

Let the input mode = 4-20 mA, and parameters “Lo C” and “Hi C” equal to -300 and 1200

respectively. The calculations will be done for three different input currents from example 2.

a)  $I_{in} = 10 \text{ mA}$  and  $I_n = 0,375$

Accordingly to expression on page 27 for linear characteristic:

$0,375 \times [1200 - (-300)] \cong 562$  and next, the “Lo C” value is added to the result , so the displayed value:

$$W \cong 562 + (-300) = 262$$

b)  $I_{in} = 2,5 \text{ mA}$  and  $I_n = -0,0938$ .

$$W \cong -441.$$

c)  $I_{in} = 20,5 \text{ mA}$  and  $I_n = 1,0313$ .

$$W \cong 1247.$$

#### **Example 4: The square characteristic**

Let the input mode = 4-20 mA, and parameters “Lo C” and “Hi C” equal to -300 and 1200 respectively. The calculations will be done for there different input currents from example 2.

a)  $I_{in} = 10 \text{ mA}$  and  $I_n = 0,375$

Accordingly to expression on page 27 for square characteristic:  $(0,375)^2 \times [1200 - (-300)] \cong 211$ .

and next, the “Lo C” value is added to the result , so the displayed value:

$$W \cong 211 + (-300) = -89$$

b)  $I_{in} = 2,5 \text{ mA}$  and  $I_n = -0,0938$ .

$$W \cong -287.$$

c)  $I_{in} = 20,5 \text{ mA}$  and  $I_n = 1,0313$ .

$$W \cong 1295.$$

#### **Example 5: The square root characteristic**

Let the input mode = 4-20 mA, and parameters “Lo C” and “Hi C” equal to -300 and 1200 respectively. The calculations will be done for there different input currents from example 2.

a)  $I_{in} = 10 \text{ mA}$  and  $I_n = 0,375$

Accordingly to expression on page 28 for square root characteristic:

$$\sqrt{0,375} \times [1200 - (-300)] \cong 919.$$

and next, the “Lo C” value is added to the result , so the displayed value:

$$W \cong 919 + (-300) = 619$$

b)  $I_{in} = 2,5 \text{ mA}$  and  $I_n = -0,0938$  , normalized result is negative , so the displayed value is equal to “Lo C” parameter:  $W \cong \text{“Lo C”} = -300$ .

c)  $I_{in} = 20,5 \text{ mA}$  and  $I_n = 1,0313$ .

$$W \cong 1223.$$

#### **Example 6: The user defined characteristic**

Let the input mode = 4-20 mA, and the user selected the 10 segment characteristic. To do this it is necessary to enter X and Y coordinates of 11 points (see **Menu "InPt"**). The calculations will be done for three different input currents from example 2, so in calculations some of the segments will be used only.

Let the following points will be given:

X1 = "00.0", Y1 = "-50.0",

X2 = "10.0", Y2 = "-30.0",

....

X6 = "30.0", Y6 = "30.0",

X7 = "40.0", Y7 = "80.0",

....

X10 = "90.0", Y10 = "900.0",

X11 = "100.0", Y11 = "820.0",

Additionally all other points must to be defined and stored in the device memory.

a)  $I_{in} = 10 \text{ mA}$  and  $I_n = 0,375$

The segment defined by X6 = "30.0" and X7 = "40.0" for this  $I_n$  will be selected. Accordingly to expressions given for user defined characteristic (see page 28)  $X6(PL) = 30$ ,  $Y6(PL) = 30$ ,  $X7(PH) = 40$ ,  $Y7(PH) = 80$  and  $I_p = 0,3$ , the displayed value :

$$W = (I_n - I_p) \times \frac{[Y(PH) - Y(PL)]}{[X(PH) - X(PL)]} \times 100 + Y(PL) =$$

$$= (0,375 - 0,3) \times \frac{[80 - 30]}{[40 - 30]} \times 100 + 30 \approx 67$$

b)  $I_{in} = 2,5 \text{ mA}$  and  $I_n = -0,0938$ , because of the normalized  $I_n$  value is lower than 0, the segment defined by X1 and X2 will be selected.  $X1(PL) = 0$ ,  $Y1(PL) = -50$ ,  $X2(PH) = 10$ ,  $Y2(PH) = -30$  and  $I_p = 0$ . For these values the displayed value  $W \approx -69$ .

c)  $I_{in} = 20,5 \text{ mA}$  and  $I_n = 1,0313$ , because of the normalized  $I_n$  value is higher than 1, the segment defined by X10 and X11 will be selected, and  $X10(PL) = 90$ ,  $Y10(PL) = 900$ ,  $X11(PH) = 100$ ,  $Y11(PH) = 820$  and  $I_p = 0,9$  for these values the displayed value  $W \approx 795$ .

### **Example 7: Volume characteristics of a cylindrical tank in the vertical position**

We assume that the user has oil tank in the shape of the cylinder located in vertical position. The tank has dimension: height 10m, diameter 4m and length of the sensor 10m. The output of signal of the sensor has 4±20mA range.

In first step, we set type of input range 4±20mA (see parameter MENU->"InPt"->"tYPE").

Next we defined the parameters of tank dimension and location of sensor:

„t Sn"=00,00

„t Sh"=10,00



„t h1”=00,00  
 „t h2”=10,00  
 „t h3”=00,00  
 „t d”=04,00

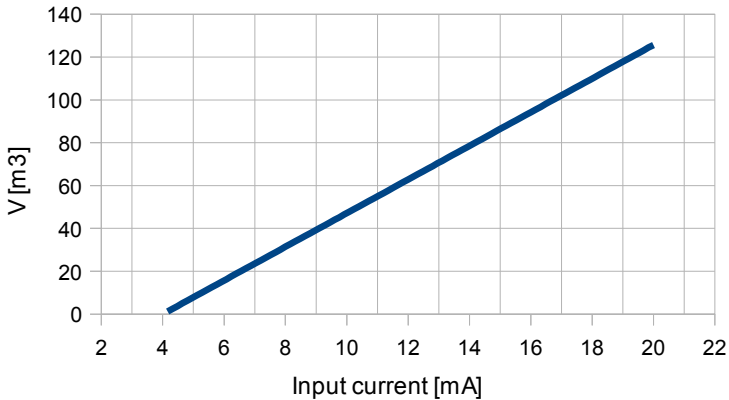

Figure 9.6 The volume characteristic of tank depending on input current in 4÷20mA range.

**Example 8: Volume characteristics of a cylindrical tank in the horizontal position**

We assume that the user has tank for wheat in the shape of the cylinder located in horizontal position. The tank has dimension: height in first part is 2m, height in second part is 8.05m, diameter 3.26m and length of the sensor 10m. The output of signal of the sensor has 4÷20mA range.

In first step, we set type of input range 4÷20mA (see parameter MENU->”InPt”->”tYPE”). Next we defined the parameters of tank dimension and location of sensor:

„t Sn”=00,00  
 „t Sh”=10,00  
 „t h1”=02,00  
 „t h2”=08,05  
 „t h3”=00,00  
 „t d”=03,26

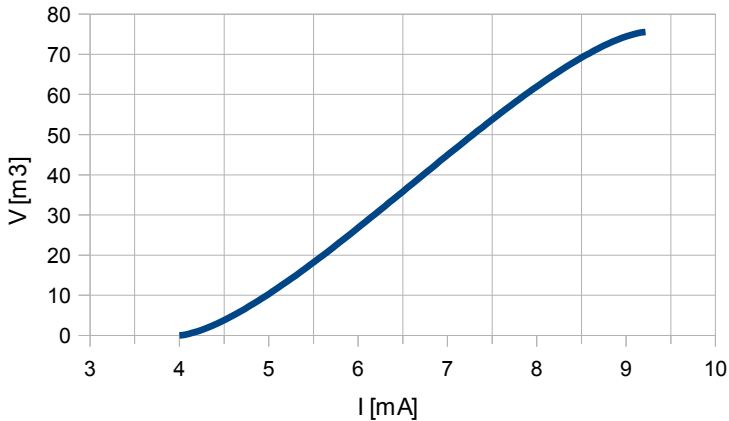

Figure 9.7 The volume characteristic of tank depending on input current in 4÷20mA range.

## **10. THE MODBUS PROTOCOL HANDLING**

Transmission parameters: 1 start bit, 8 data bits, 1 or 2 stop bit (2 bits are send, 1 and 2 bits are accepted when receive), no parity control  
 Baud rate: selectable from: 1200 to 115200 bits/second  
 Transmission protocol: MODBUS RTU compatible

The device parameters and display value are available via RS-485 interface, as HOLDING-type registers (numeric values are given in U2 code) of Modbus RTU protocol. The registers (or groups of the registers) can be read by 03h function, and wrote by 06h (single registers) or 10h (group of the registers) accordingly to Modbus RTU specification. Maximum group size for 03h and 10h functions can not exceeds 16 registers (for single frame).



The device interprets the broadcast messages, but then do not sends the answers.

**10.1. LIST OF REGISTERS**

<b>Register</b>	<b>Write</b>	<b>Range</b>	<b>Register description</b>
01h	No	-999 ÷ 9999	Measurement value (no decimal point)
02h	No	0h, A0h, 60h	The status of the current measurement; <b>0h</b> - data valid; <b>A0h</b> - top border of the measurement range is exceeded; <b>60h</b> - bottom border of the measurement range is exceeded;
03h	Yes	0 ÷ 3	<b>"Pnt"</b> parameter in <b>"InPt"</b> menu (decimal point position) <b>0</b> - " 0"; <b>1</b> - " 0.0"; <b>2</b> - " 0.00"; <b>3</b> - "0.000"
06h	No	-999 ÷ 9999	Peak (drop) value (no decimal point)
10h	Yes	0 ÷ 5	<b>"tyPE"</b> parameter in <b>"InPt"</b> menu (nominal input range). <b>0</b> - 0-20 mA range; <b>1</b> - 4-20 mA range; <b>2</b> - 0-10 V range; <b>3</b> - 2-10 V range; <b>4</b> - 0-5 V range; <b>5</b> - 1-5 V range
11h	Yes	0 ÷ 3	<b>"CHAR"</b> parameter in <b>"InPt"</b> menu (characteristic type) <b>0</b> - linear; <b>1</b> - square; <b>2</b> - square root; <b>3</b> - user defined
12h	Yes	0 ÷ 5	<b>"FiLt"</b> parameter in <b>"InPt"</b> menu (measurement filtering rate)
13h	Yes	0 ÷ 3	<b>"Pnt"</b> parameter in <b>"InPt"</b> menu (the copy of 03h register, decimal point position) <b>0</b> - " 0"; <b>1</b> - " 0.0"; <b>2</b> - " 0.00"; <b>3</b> - "0.000"
14h	Yes	-999 ÷ 9999	<b>"Lo C"</b> parameter in <b>"InPt"</b> menu, no decimal point included
15h	Yes	-999 ÷ 9999	<b>"Hi C"</b> parameter in <b>"InPt"</b> menu, no decimal point included
16h	Yes	0 ÷ 999	<b>"Lo r"</b> parameter in <b>"InPt"</b> menu, in 0.1%
17h	Yes	0 ÷ 199	<b>"Hi r"</b> parameter in <b>"InPt"</b> menu, in 0.1%
20h <sup>2</sup>	Yes	0 ÷ 199	Device address
21h	No	20F2h	Device identification code (ID)
22h <sup>3</sup>	Yes	0 ÷ 7	<b>"bAud"</b> parameter in <b>"rS"</b> menu (baud rate); <b>0</b> - 1200 baud; <b>1</b> - 2400 baud; <b>2</b> - 4800 baud; <b>3</b> - 9600 baud; <b>4</b> - 19200 baud; <b>5</b> - 38400 baud; <b>6</b> - 57600 baud; <b>7</b> - 115200 baud
23h <sup>4</sup>	Yes	0 ÷ 1	<b>"mbAc"</b> parameter in <b>"rS"</b> menu (permission to write registers via RS-485 interface); <b>0</b> - write denied; <b>1</b> - write allowed
25h	Yes	0 ÷ 5	<b>"rESP"</b> parameter in <b>"rS"</b> menu (additional response delay); <b>0</b> - no additional delay; <b>1</b> - "10c" option; <b>2</b> - "20c" option; <b>3</b> - "50c" option; <b>4</b> - "100c" option; <b>5</b> - "200c" option;
2Dh	Yes	1 ÷ 8	<b>"bri"</b> parameter (display brightness); <b>1</b> - the lowest brightness; <b>8</b> - the highest brightness
2Fh	Yes	0 ÷ 1	<b>"Edit"</b> parameter (numerical parameters edit mode); <b>0</b> - „dig" mode; <b>1</b> - „SLid" mode
50h	Yes	0 ÷ 1	<b>"modE"</b> parameter in <b>"HOLD"</b> menu (type of detected changes): <b>0</b> - peaks; <b>1</b> - drops
51h	Yes	0 ÷ 9999	<b>"PEA"</b> parameter in <b>"HOLD"</b> menu (minimum detectable change, no decimal point included)

Register	Write	Range	Register description
52h	Yes	0 ÷ 199	"timE" parameter in "HOLd" menu, maximum peaks' (or drops') display time expressed in seconds
53h	Yes	0 ÷ 1	"HdiS" parameter in "HOLd" menu: 0 - "rEAL" mode ; 1 - "HOLd" mode
70h <sup>5</sup>	Yes	-999 ÷ 1999	The value of „X" coordinate of point no. 1 of the user defined characteristic, expressed in 0.1%
71h <sup>5</sup>	Yes	-999 ÷ 9999	The value of „Y" coordinate of point no. 1 of the user defined characteristic, no decimal point included
72h <sup>5</sup> ÷ 95h <sup>5</sup>			Further pairs of „X" - „Y" coordinates of points no. 2 ÷ 19 of the user defined characteristic
96h <sup>5</sup>	Yes	-999 ÷ 1999	The value of „X" coordinate of point no. 20 of the user defined characteristic, expressed in 0.1%
97h <sup>5</sup>	Yes	-999 ÷ 9999	The value of „Y" coordinate of point no. 20 of the user defined characteristic, no decimal point included

- 2 - after writing to register no 20h the device responds with an "old" address in the message.
- 3 - after writing to register no 22h the device responds with the new baud rate.
- 4 - the value of the "mbAc" parameter is also connected to write to this register, so it is possible to block a writes, but impossible to unblock writes via RS-485 interface, The unblocking of the writes is possible from menu level only.
- 5 - the pairs of „X" - „Y" coordinates may be defined for any free point. The pair is "free" (it means that particular point is not defined) if „X" coordinate of this point is equal 8000h. After writing both X and Y coordinate the point is defined and used in calculation of result. The coordinates of any point can be changed at any time.

## **10.2. TRANSMISSION ERRORS DESCRIPTION**

If an error occurs while write or read of single register, then the device sends an error code according to Modbus RTU specifications (example message no 1).

Error codes:

**01h** - illegal function (only functions 03h, 06h and 10h are available),

**02h** - illegal register address

**03h** - illegal data value

**08h** - no write permission ( see: “**mbAc**” parameter)

**A0h** - exceed of upper border of input range

**60h** - exceed of lower border of input range

A0h and 60h codes can appear only during reg. 01h is reading by 03h function (read of a single register).

## **10.3. EXAMPLES OF QUERY/ANSWER FRAMES**

Examples apply for device with address 1. All values are represent hexadecimal.

**Field description:**

**ADDR** Device address on modbus network

**FUNC** Function code

**REG H,L** Starting address (address of first register to read/write, Hi and Lo byte)

**COUNT H,L** No. of registers to read/write (Hi and Lo byte)

**BYTE C** Data byte count in answer frame

**DATA H,L** Data byte (Hi and Lo byte)

**CRC L,H** CRC error check (Hi and Lo byte)

### **1. Read of the displayed value (measurement), WW-30 device address = 01h:**

ADDR	FUNC	REG H,L		COUNT H,L		CRC L,H	
01	03	00	01	00	01	D5	CA

a) The answer (we assume that measurement is not out of range):

ADDR	FUNC	BYTE C	DATA H,L		CRC L,H	
01	03	02	00	FF	F8	04

DATA H, L - displayed value = 255, no decimal point.

Decimal point position can be read from reg. 03h.

b) The answer (if an error occur):

ADDR	FUNC	ERROR	CRC L,H	
01	83	60	41	18

ERROR - error code = 60h, bottom border of the measurement range is exceeded

## 2. Read of device ID code

ADDR	FUNC	REG H,L		COUNT H,L		CRC L,H	
01	03	00	21	00	01	D4	00

The answer:

ADDR	FUNC	BYTE C	DATA H,L		CRC L,H	
01	03	02	20	F2	20	01

DATA - identification code (20F2h)

## 3. Change of the device address from 1 to 2 (write to reg. 20h)

ADDR	FUNC	REG H,L		DATA H,L		CRC L,H	
01	06	00	20	00	02	09	C1

DATA H - 0

DATA L - new device address (2)

The answer (the same as the message):

ADDR	FUNC	REG H,L		DATA H,L		CRC L,H	
01	06	00	20	00	02	09	C1

## 4. Change of baud rate of all devices connected to the net (BROADCAST message).

ADDR	FUNC	REG H,L		COUNT H,L		CRC L,H	
00	06	00	22	00	04	29	D2

DATA H - 0

DATA L - 4, new baud rate 19200 baud



Device do not reply to BROADCAST-type messages.

**5. Read of the registers 1, 2 and 3 in one message (example of reading a number of registries in one frame):**

ADDR	FUNC	REG H,L		COUNT H,L		CRC L,H	
01	03	00	01	00	03	54	0B

COUNT L - the count of being read registers (max.16)

The answer:

ADDR	FUNC	BYTE C	DATA H1,L1		DATA H2,L2		DATA H3,L3		CRC L,H	
01	03	06	00	0A	00	00	00	01	78	B4

DATA H1, L1 - reg. 01h (10 - displayed value "1.0"),

DATA H2, L2 - reg. 02h (0 - no errors),,

DATA H3, L3 - reg. 03h (1 - decimal point position " 0.0").



**There is no full implementation of the Modbus Protocol in the device. The functions presented above are available only.**

**11. DEFAULT AND USER'S SETTINGS LIST**

<i>Parameter</i>	<i>Description</i>	<i>Default value</i>	<i>User's value</i>	<i>Desc. page</i>
<b>Configuration of measurement input ("inPt" menu)</b>				
tYPE	Input mode	„4-20“		17
CHAr	Conversion characteristic mode	Lin		17
FILt	Filtering ratio	0		17
Pnt	Decimal point position	0.0		17
Lo C	Minimum displayed value (for nominal range)	000.0		18
Hi C	Maximum displayed value (for nominal range)	100.0		18
Lo r	Extension of the bottom of the nominal input range	5.0 (%)		21
Hi r	Extension of the top of the nominal input range	5.0 (%)		21
<b>Display parameters</b>				
bri	Display brightness	bri6		22
<b>Configuration of peaks detection function ("HOLd" menu)</b>				
modE	Kind of detected changes	norm		23
PEA	Minimum detected change	0.0		23
timE	Maximum time of peak displaying	0.0		23
HdiS	The type of displayed value	HOLd		23
<b>RS 485 interface configuration (menu "rS")</b>				
Addr	Device address	0		23
bAud	Baud rate	9.6		23
mbAc	Permission to changes of configuration registers	on		24
rESP	Additional delay of answer transmission	Std		24
<b>Configuration of numerical parameters edition</b>				
Edit	Numerical parameters edit mode	dig		24











**APLISENS S.A. , ul. Morelowa 7  
PL - 03-192 Warszawa, Poland**

**tel.: (+48 22) 814-07-77, fax: (+48 22) 814-07-78**

**<http://www.aplisens.com.pl>, e-mail: [aplisens@aplisens.pl](mailto:aplisens@aplisens.pl)**